

# Assembly Instructions

# BIFOLD ARMS MADISON ARM

See below for Preparation of arms for assembly.

## 1 One pair of Bifold Arms

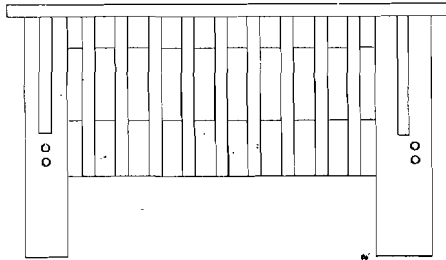

Outside View

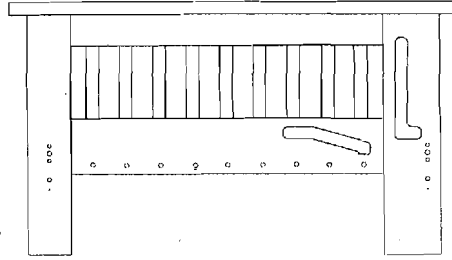

Inside View

## 2 Hardware in this box.



100 mm Bolts x 4 Pieces



Barrel Nuts x 8 Pieces



Wooden Dowel x 4 Pieces



Wood Button x 8 Pieces



60mm Bolts x 4 Pieces

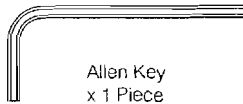

Allen Key x 1 Piece



16mm Bolts x 4 Pieces

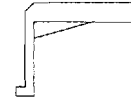

Stretcher Bracket x 4 Pieces

## 3 Fasten Stretcher Brackets to Arm.

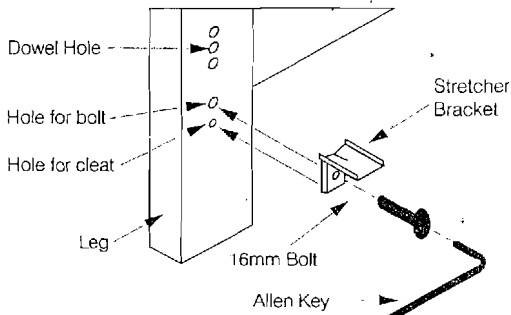

- Insert the Stretcher Bracket Cleat into the hole provided.
- IMPORTANT:** Don't fully tighten Bracket until Stretchers are all in place for easy alignment.
- Each arm requires two brackets, front and back.



## 4 Fit Wooden Dowels

Tap Wooden Dowels all the way into the middle hole before assembly to Arms.

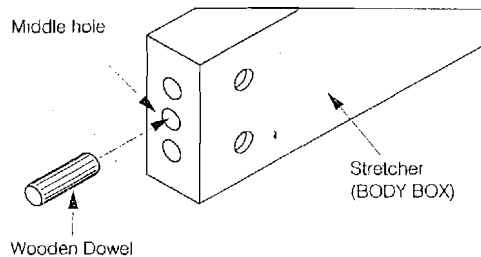

## 5 Fit Wood Buttons into Arm Holes.

AFTER TOTAL ASSEMBLY:

Tighten all bolts.

Push fit or lightly tap the Wooden Buttons into the Bolt holes on the Arms.

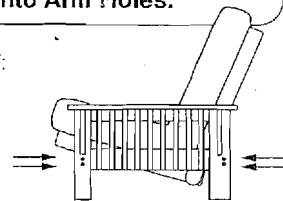

1 Instructions for Bifold Body assembly, are packed in the Body box.

**Assembly  
Instructions**

# FUTON FRAME BIFOLD BODY

Instructions apply for  
Chair, Double, Queen

**Parts in this Box:**

Slat Support  
preattached

Back Deck

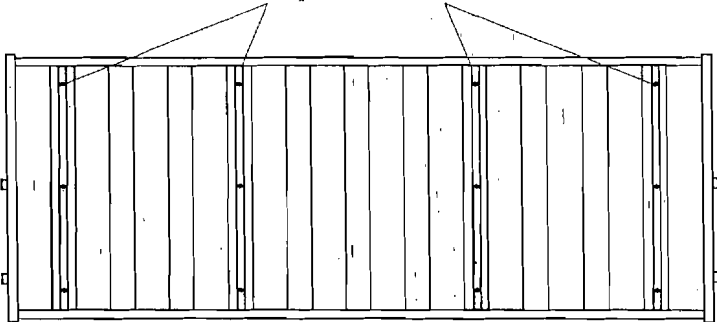

Seat Deck

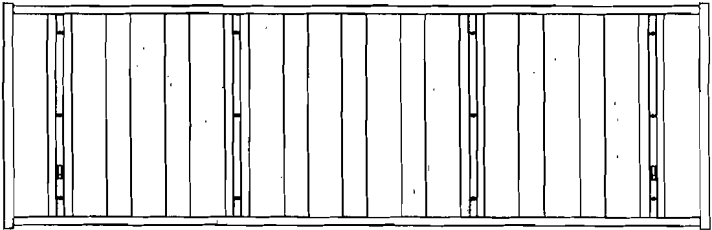

Side Rails with preattached  
metal hinge mechanism

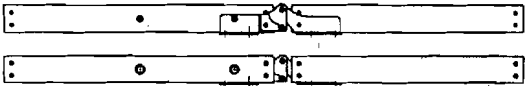

Back Strecher rail 1 pc

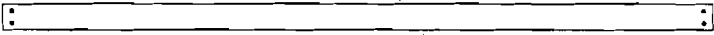

Front Strecher rail 1 pc

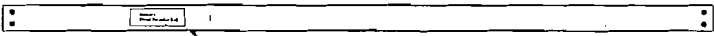

Front Stretcher Rail shown with Sticker

**Hardware in this box:**



M6x60mm Bolt 16 pcs

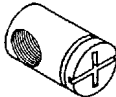

M6 Barrel Nuts 16 pcs



Wood Buttons 4 pcs



Allen key 1 pc

**Figure . 1**

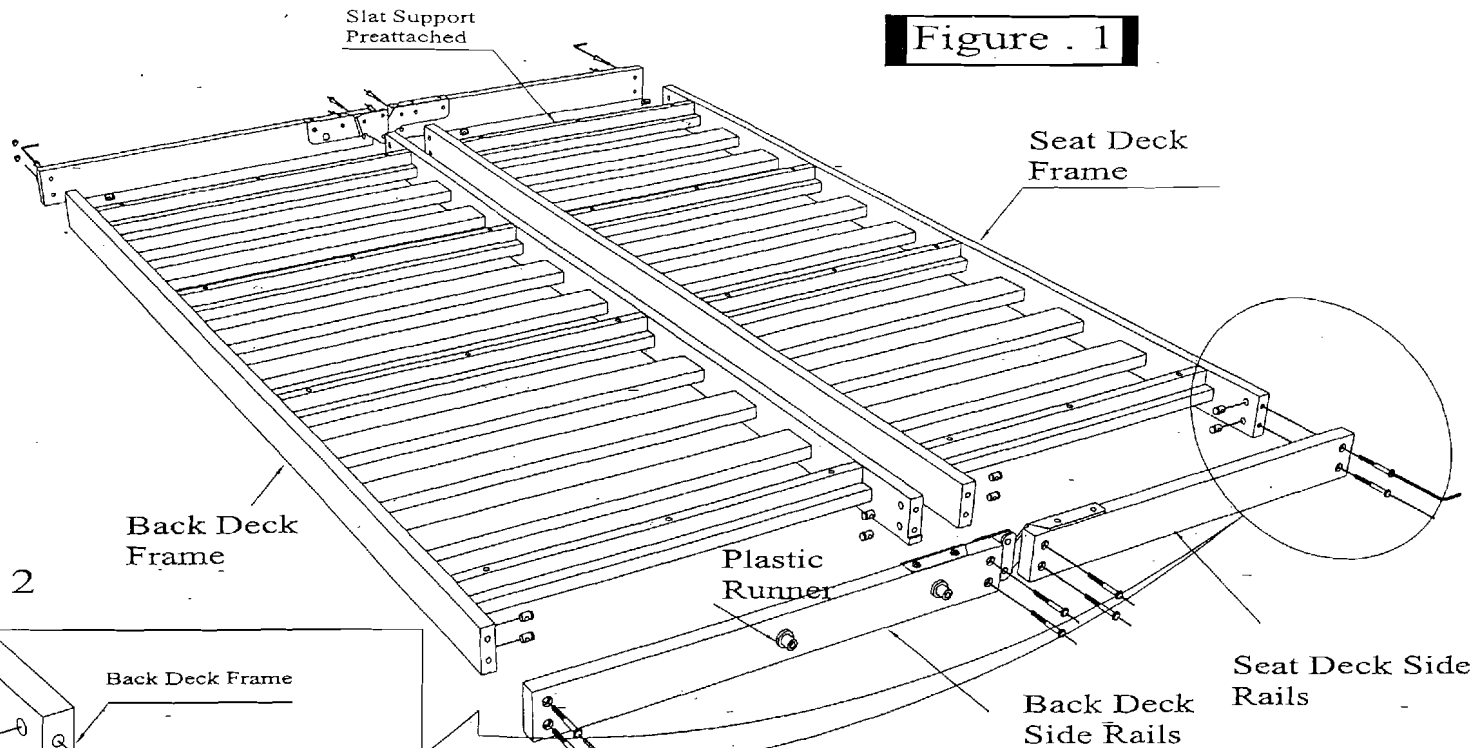

**Figure . 2**

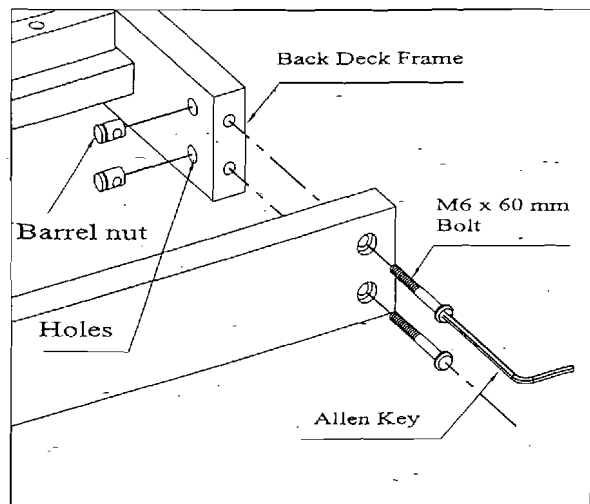

**Step 1**

1. Open the box and remove hardware bag. Check to see if all the hardware given on packing list is present.
2. Attached the assembled Side Rails to the seat deck and back deck frames as shown use M6 x 60 mm bolt. ( figure. 1 - figure 2).

## Step 2

1. Open the bifold arm box.
2. Remove the arms and hardware bag in box arms, also assembly instructions for arm.
3. Assemble the stretcher rails to the arm as shown in figure 3. Tap the wooden dowel to each end of stretcher rails, as shown in figure 4.
4. Detailed procedure of fixing the bolt and barrel nut is illustrated in figure 4 and figure 5.

After fixed stretcher rails on arm,  
DO NOT TIGHTEN THE BOLT YET.

Figure. 5

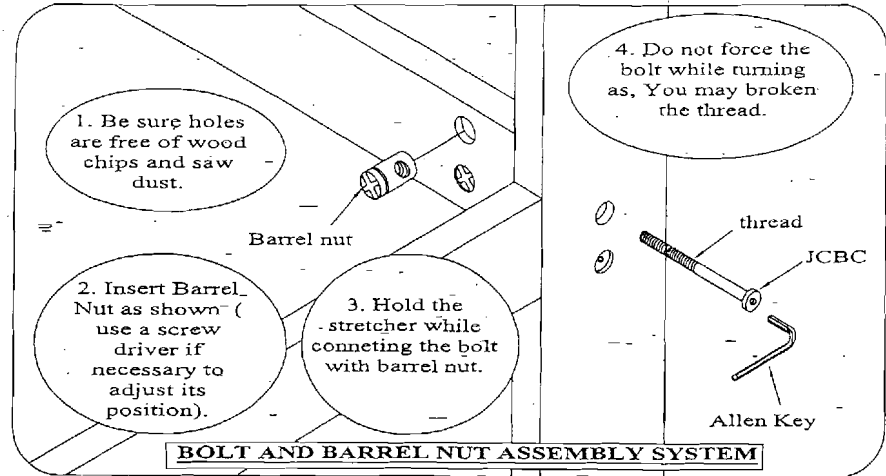

Figure. 3

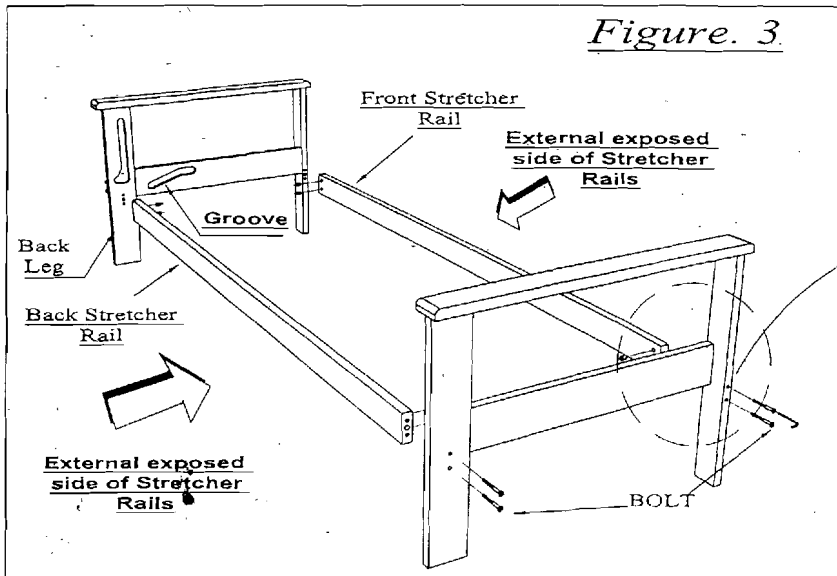
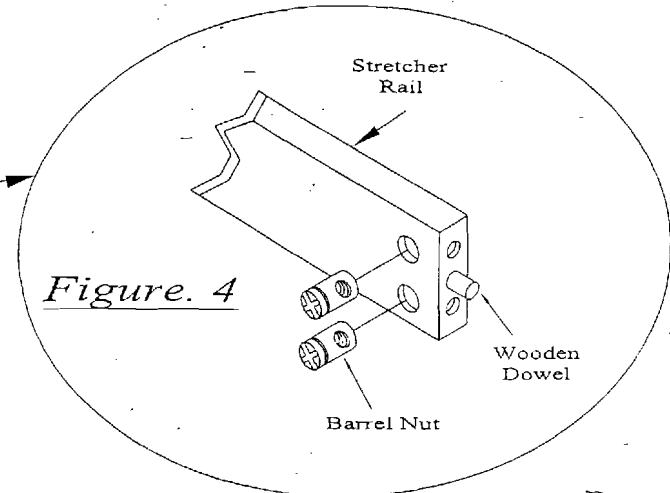
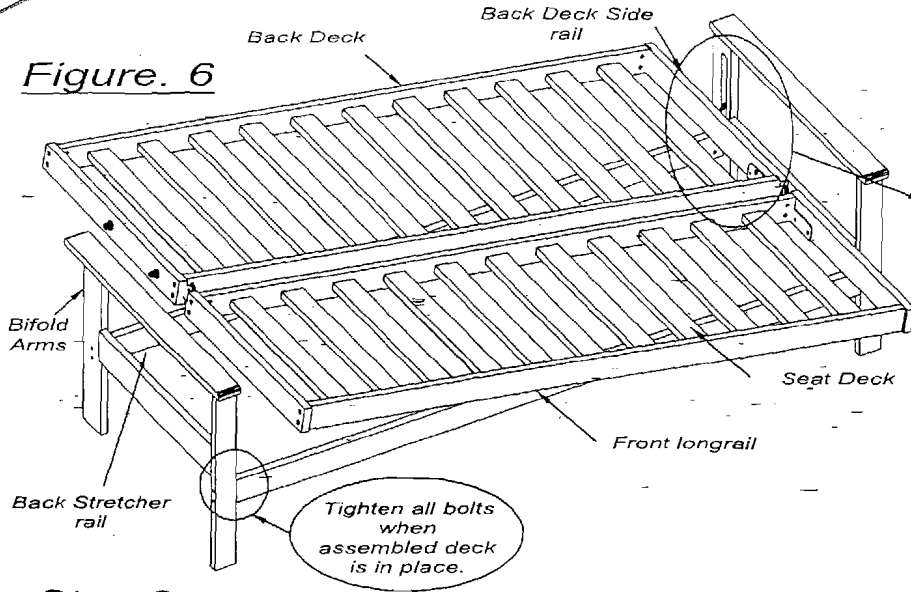

Figure. 4



**Figure. 6**



**Figure. 7**

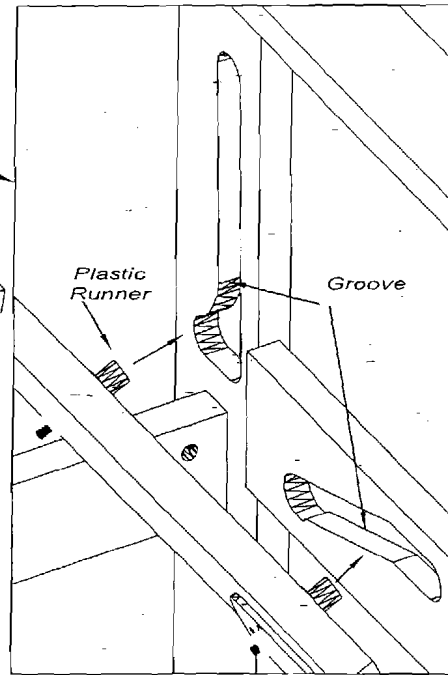

**Caution :**  
 The Plastic Runners can damage the arm rest if you are careless....  
 Ease in carefully

**Step 3**

1. Place the Back deck between both bifold Arms. Fit the Plastic Runner into grooves in the Arms. Make sure that the rear side is facing downwards. ( figure.6 and figure.7 )

**Insert the back deck oriented flat. Insert one end of the back deck first then gently lower and position the other end.**

**Caution: this step can be tricky**  
**It should be done by two or more people**

2. Once the back deck is in place, tighten all the bolts that you have left untightened in Step 3.

**Step 4 ( for Queen Size Only )**

1. Attach the small leg on to Back deck siderails with M6 x 50 mm bolt. ( figure. 8 and figure. 9 )

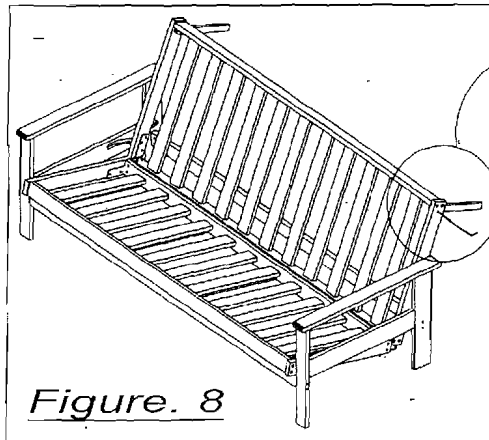

**Figure. 8**

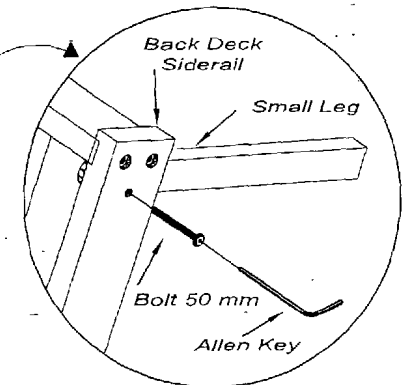

**Figure. 9**

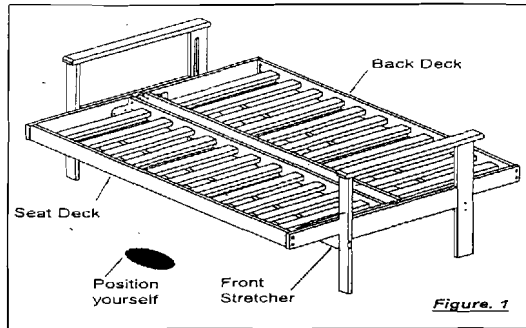

Figure 1

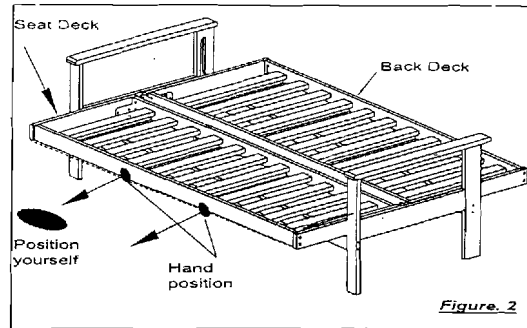

Figure 2

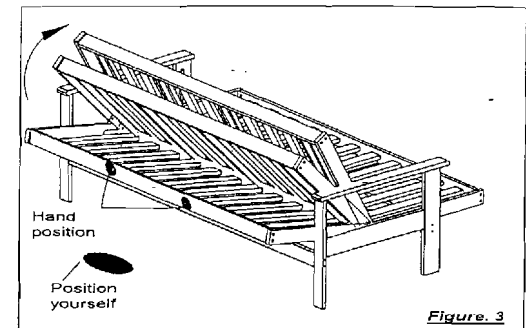

Figure 3

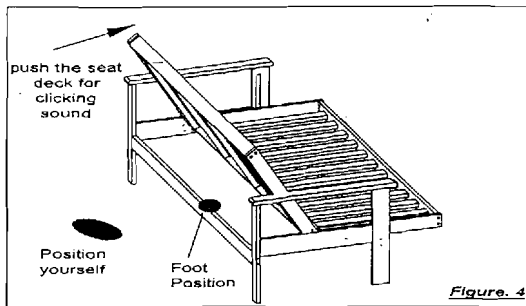

Figure 4

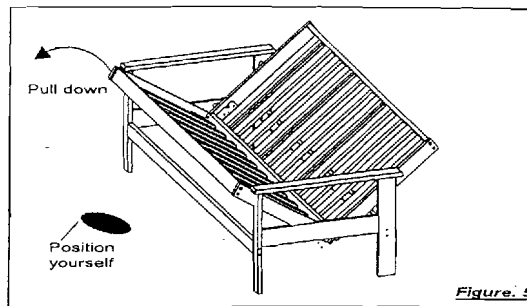

Figure 5

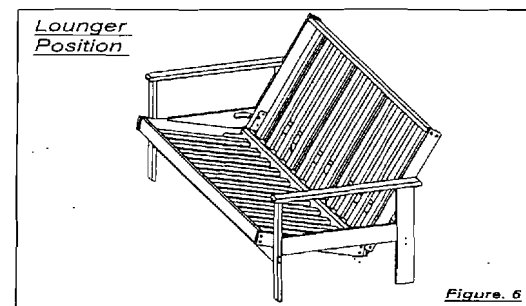

Figure 6

### Converting the Bed to Lounger Position.

1. Position yourself in front of the seat deck. ( figure 1 )
2. Pull the front long rail forward to unlock the safety lock. ( figure 2 )
3. Standing in the middle of the frame, lift up the seat deck using both hands 3 feet apart to ensure even force is applied in order to lock the seat deck in the lounge position. ( figure 3 )
4. Push the seat deck until you hear the clicking sound. That is the lock for the lounge position. ( figure 4 ). It is more comfortable if you put one of your foot on the front stretcher rail while pushing the seat deck backwards.
5. Pull down the seat deck gently and rest it on the front stretcher rail. (figure 5 ).
6. Adjust the mattress as needed.

Operation  
Instruction  
of Frame  
Click -  
Click  
Mechanicsm  
Body

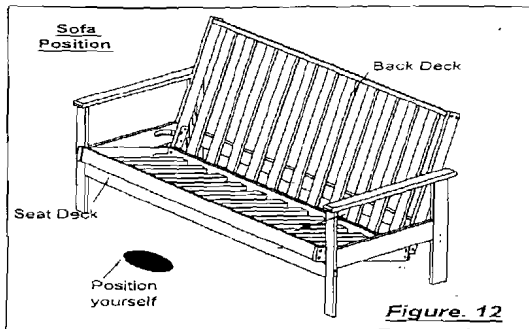

Figure 12

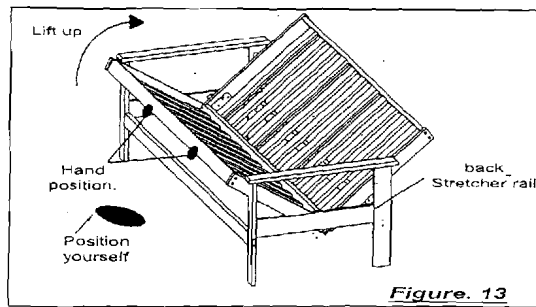

Figure 13

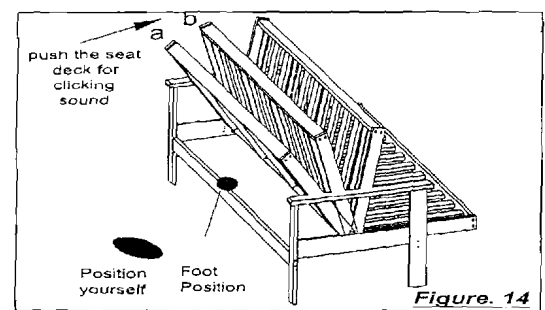

Figure 14

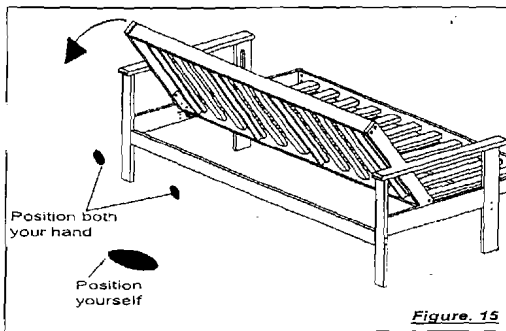

Figure 15

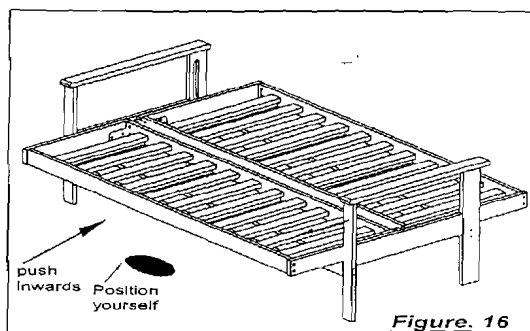

Figure 16

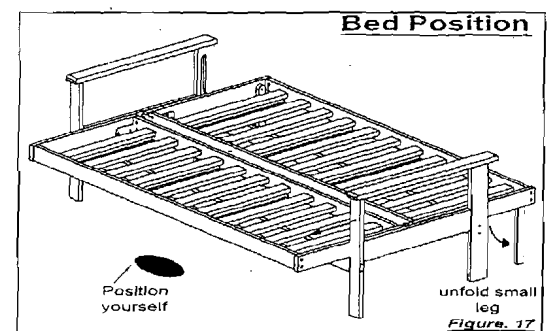

Figure 17

### Converting the Sofa/Lounger to Bed Position.

1. Position yourself in front of the seat deck. ( figure 12 )
2. Standing in the middle of the frame, lift up the seat deck until the back deck rest on the back stretcher rail. (figure 13).
3. To ensure even force is applied, use both hands 3 feet apart at the middle of the front long rail while pushing the seat deck for clicking sound. There are two ways to convert to the bed position:
  - a. Lounger to Bed  
Push back the seat deck to unlock. When you hear two clicking sound, it will release the lock and the lounger can be converted to bed.
  - b. Sofa to Bed  
Push back the seat deck to unlock. When you hear one clicking sound, it will release the lock and the sofa can be converted to bed.  
It is more comfortable if you put one of your foot on the front stretcher rail while pushing the seat deck backwards. (figure 14)
4. Pull down the seat deck gently and rest it on the front stretcher rail. ( figure 15 ).
5. Push inwards to lock the bed position. (figure 16). If you have queen size frame, unfold the small legs at the back deck. ( figure 17 ).
6. Adjust the mattress as needed.